

Article number: 021816011333

Description: Clamp with bracket and rubber  
SPGU 6011. 333/30 SK

## Measures

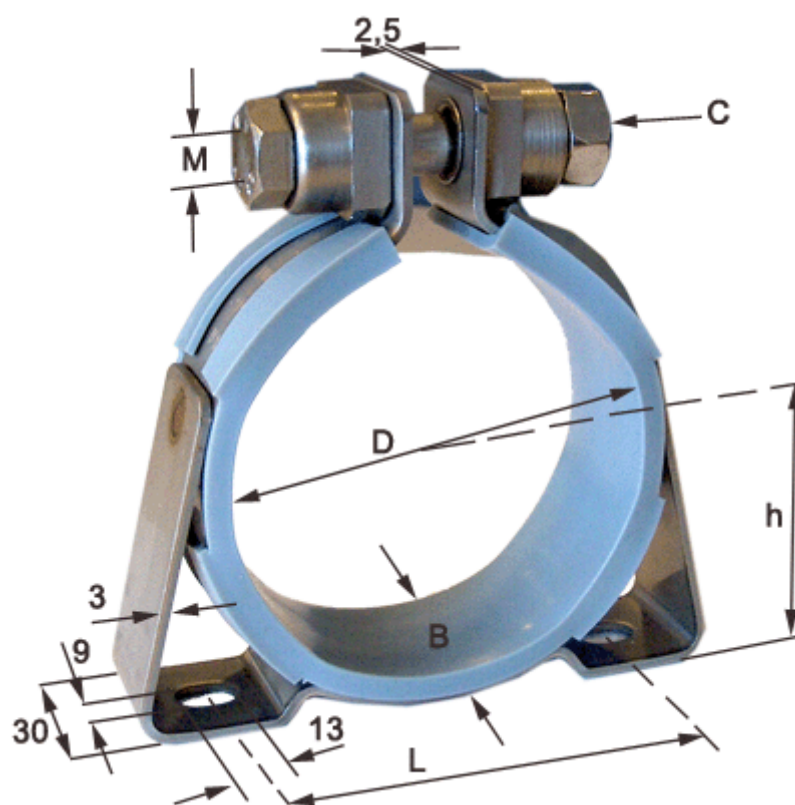

C (screw type) = SK hexagon screw

Diameter D = 333

h = 175

L = 345

Width B = 30